

Pre-fill Valve

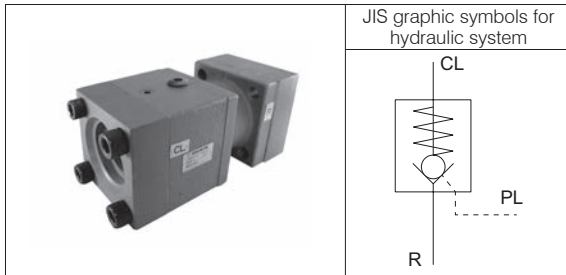

Features

- These valves are used to suction/discharge fluid between a hydraulic cylinder and a tank. In applications to large hydraulic press structures, the valve sucks hydraulic fluid from the tank to the hydraulic cylinder in the fast forward process, blocks reverse flow from the hydraulic cylinder to the tank in the pressurizing process, and discharges hydraulic fluid from the hydraulic cylinder to the tank in the return process.

Nomenclature

⊗ - **HPF** - **F** ⊗ ⊗ - ⊗ - ⊗ ⊗ - ⊗

1 2 3 4 5 6 7

1 Applicable fluid code

No designation: Petroleum-based hydraulic fluid, water-glycol hydraulic fluid

F: Phosphate ester hydraulic fluid

2 Model No.

HPF: H series pre-fill valve

3 Connections

F : Flange connection type

4 Nominal diameter

16: 2 20: 2½ 24: 3 32: 4

5 Cracking pressure code

1: 0.005 MPa {0.05 kgf/cm²}

2: 0.015 MPa {0.15 kgf/cm²}

6 Design No. (The design No. is subject to change)

10: Nominal diameter 16 (2), 24 (3), 32 (4)

20: Nominal diameter 20 (2½)

7 Option code

No designation: With flange *¹

N: Without flange

Note: *¹ For specifications with flange, the valves with the nominal diameters of 16, 20 and 24 are provided with the flanges for the CL side and R side, and the valves with the nominal diameter 32 are provided with the flange for the R side.

Specifications

Model code	Nominal diameter	Maximum operating pressure MPa {kgf/cm ² }			Maximum flow rate L/min		Area ratio Seat: Pilot piston	Mass * ² kg
		CL side	R side	Pilot pressure	R → CL	CL → R		
HPF-F16-⊗-10	2	25 {250}	2 {20}	25 {250}	160	320	1.66:1	6.1
HPF-F20-⊗-20	2½				320	640	2.37:1	12
HPF-F24-⊗-10	3				500	1000	2.93:1	15.5
HPF-F32-⊗-10	4				900	1800	3.05:1	18.9

Note: *² The masses of the flange and bolts are not included.

Handling

● Installation and maintenance

- When installing the valve below the fluid level in the open tank, keep the height difference within 1 m for cracking pressure type 1 and within 2.5 m for cracking pressure type 2. When installing it above the fluid level, adequate consideration should be given to the capacity to suck hydraulic fluid from the tank to the cylinder.

● Pilot operation

- The minimum pilot pressure required to open the valve is approximately equivalent to the cylinder side (CL side) pressure multiplied by the area ratio given above.
- When discharging hydraulic fluid from the cylinder, depressurize the cylinder side and then apply pressure at the pilot port (PL port).

● Back pressure in the pilot line

- When opening the pilot line to the tank, make the pipe resistance as low as possible and connect the piping to the tank without merging to other lines. High back pressure and pipe resistant prolongs the valve's reseal time and the valve will not close if the back pressure is 0.2 MPa {2 kgf/cm²} or higher.

● The cracking pressure cannot be changed by setting at the product.

Handling (HPF-F32)

● The special flange for the tank side (R side) is provided with its mounting bolts.

When not using the special flange for the tank side (R side), follow the dimensions of the special flange for the installation dimensions and use a tank port (port R) with an inner diameter of φ130 and a minimum depth of 120. Use 125A (5B) pipes with a schedule No. of 40 for piping to the special flange.

Hexagon socket head cap bolt	Quantity	Tightening torque N·m {kgf·m}
M22 × 150	8	620 to 780 {62 to 78}

Contact Details

Before using the product, please check the guide pages at the front of this catalog.

Internet

<https://www.daikinpmc.com/en/>

For latest information, PDF catalogs and operation manuals

Handling (HPF-F32)

- At the cylinder side (CL side), follow the dimensions of the sub-plate for the installation dimensions and use a cylinder port (port CL) with an inner diameter of $\phi 130$ and a minimum depth of 50.
- The sub-plate for the cylinder side (CL side) is not provided with the valve. Order it separately if required by specifying the model code given in the table below.

Model code	Nominal pipe diameter	Mass kg
HPF-32M	100A (4B)	33.4

Hexagon socket head cap bolt	Quantity	Tightening torque N·m {kgf·m}
M30 × 105	4	1560 to 1960 {156 to 196}

Note: The sub-plate is provided with four M30 × 105 hexagon socket head cap bolts.
Refer to Page S-11 for the dimensions of the sub-plate.

Performance curves (viscosity: 32 mm²/s {cSt})

Pressure drop characteristics (discharge) CL → R

Pressure drop characteristics (suction) R → CL

Pressure drop characteristics (suction, pilot operation) R → CL

● HPF-F16

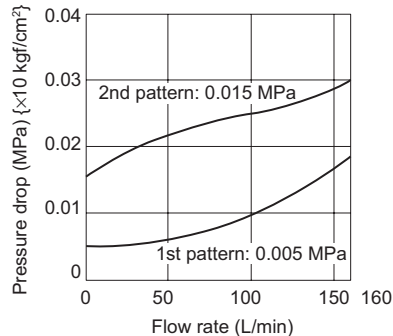
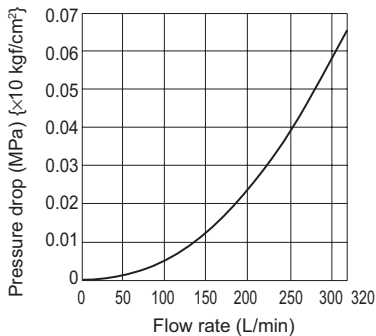

R → CL

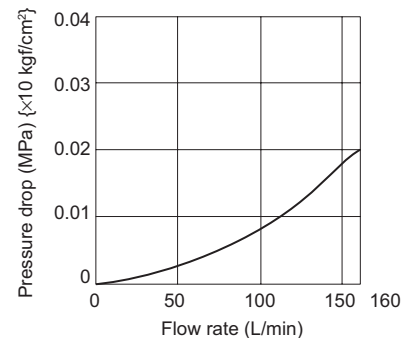

● HPF-F20

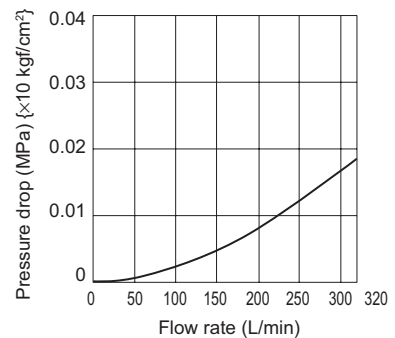
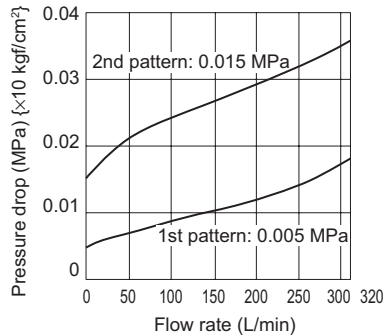
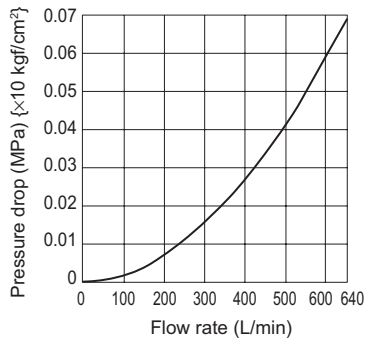

● HPF-F24

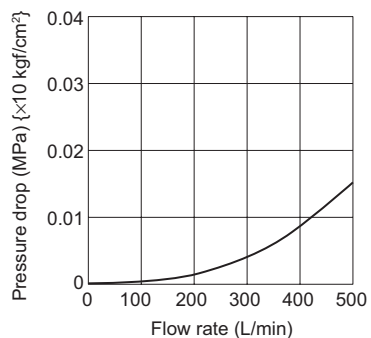
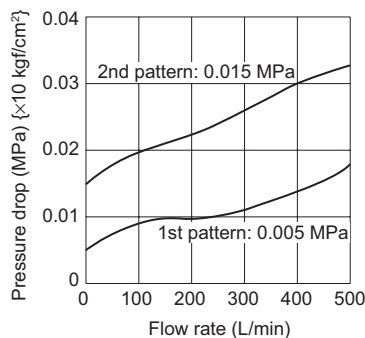
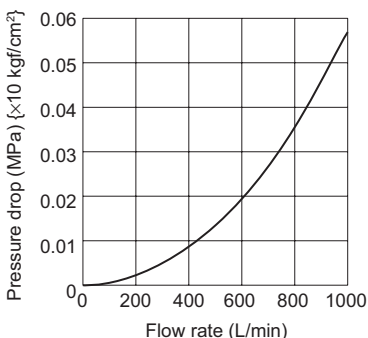

● HPF-F32

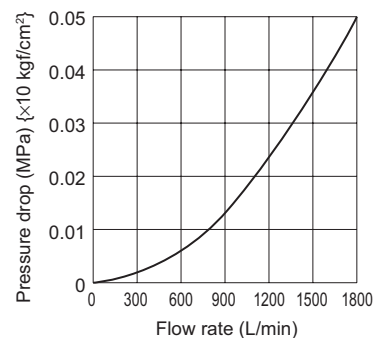
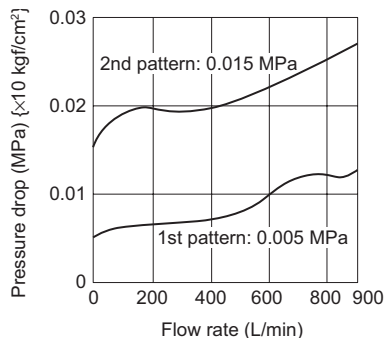
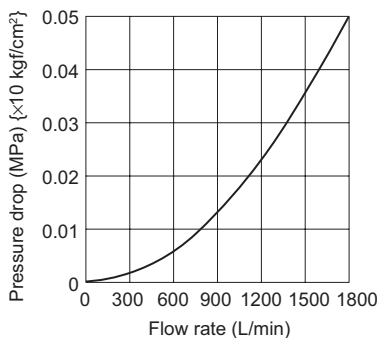

Contact Details

Before using the product, please check the guide pages at the front of this catalog.

Internet

<https://www.daikinpmc.com/en/>

For latest information, PDF catalogs and operation manuals

External dimension diagram

HPF-F16, 20, 24

Pressure gauge connection port (Rc"H")

Pilot port (port PL) (Rc"J")

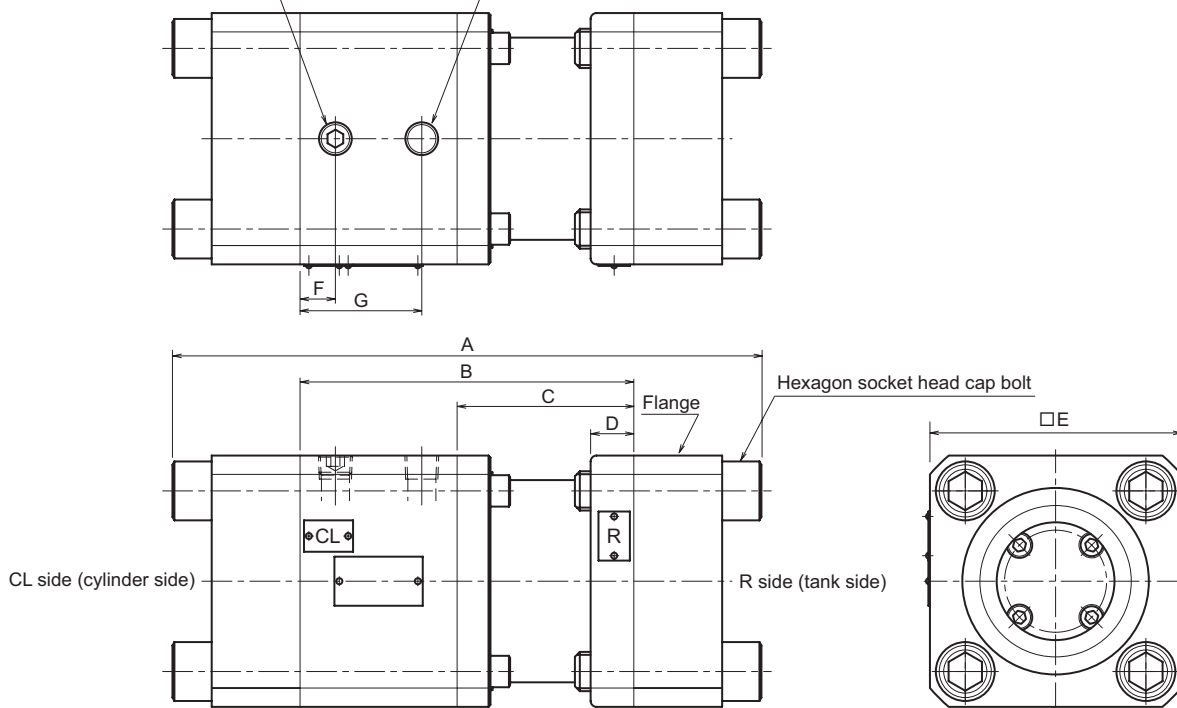

Model No.	Dimensions									Flange	Hexagon socket head cap bolt
	A	B	C	D	E	F	G	H	J		
HPF-F16	244	140	82	20	100	14	44	1/4	1/4	JIS B 2291 SSA50	M16 × 60
HPF-F20	300	170	90	22	128	18	62	3/8	3/8	JIS B 2291 SSA65	M20 × 75
HPF-F24	334	200	105	25	140	18	77	3/8	3/8	JIS B 2291 SSA80	M22 × 80

HPF-F32

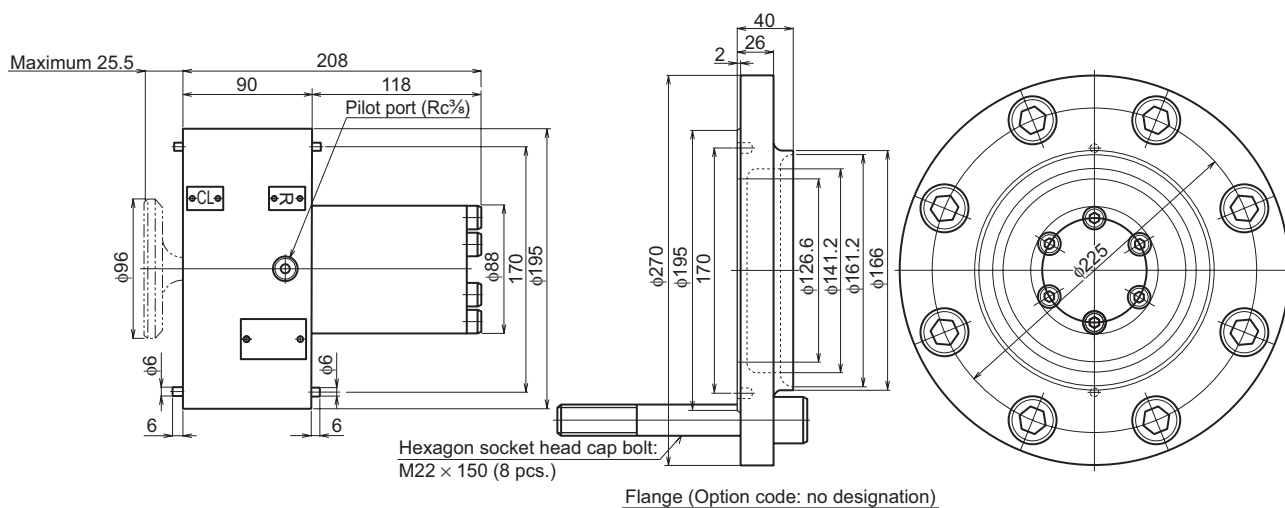

Contact Details

Before using the product, please check the guide pages at the front of this catalog.

Internet

<https://www.daikinpmc.com/en/>

For latest information, PDF catalogs and operation manuals

Sectional structural diagram

HPF-F16, 20, 24

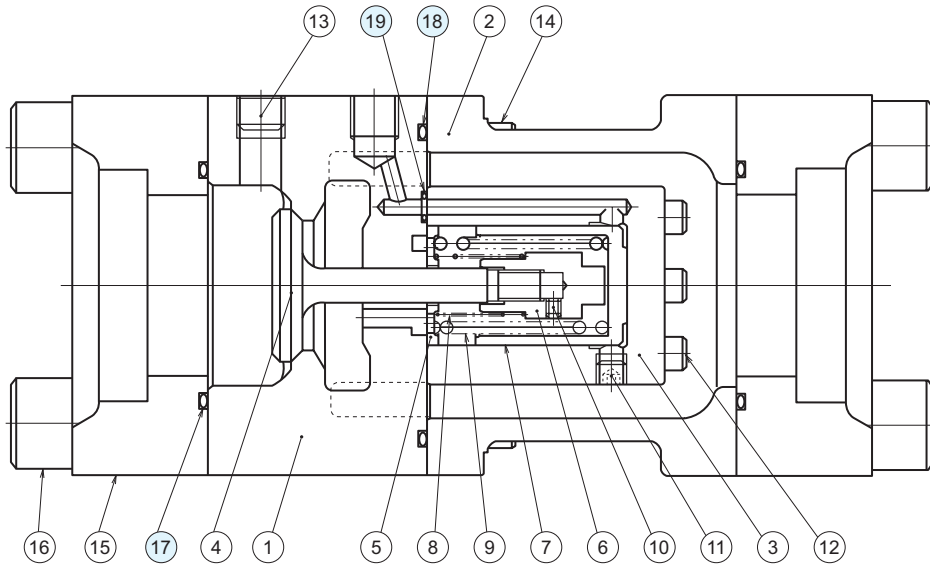

Sealing part table

Part No.	Name	Quantity	Part specifications		
			HPF-F16	HPF-F20	HPF-F24
17	O-ring	2	JIS B 2401 1B G60	JIS B 2401 1B G75	JIS B 2401 1B G85
18	O-ring	1	JIS B 2401 1B G80	JIS B 2401 1B G100	JIS B 2401 1B G110
19	O-ring	1	JIS B 2401 1B P5	JIS B 2401 1B P7	JIS B 2401 1B P7

HPF-F32

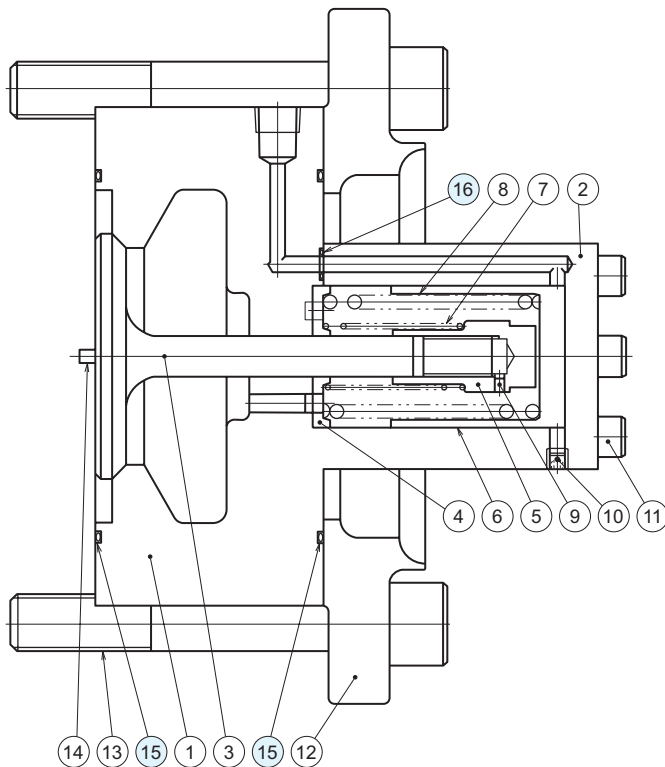

Sealing part table

Part No.	Name	Quantity	Part specifications
15	O-ring	2	JIS B 2401 1B G140
16	O-ring	1	JIS B 2401 1B P9